

El-diagram

Moto Guzzi Le Mans II

Indhold

| | |
|-----------|--|
| Side 1 | Index |
| Side 2 | Oversigt over placering af bokse og stik |
| Side 3-4 | Nøglediagram |
| Side 5-14 | Stikforbindelser |
| Side 15 | Hovedkabel |

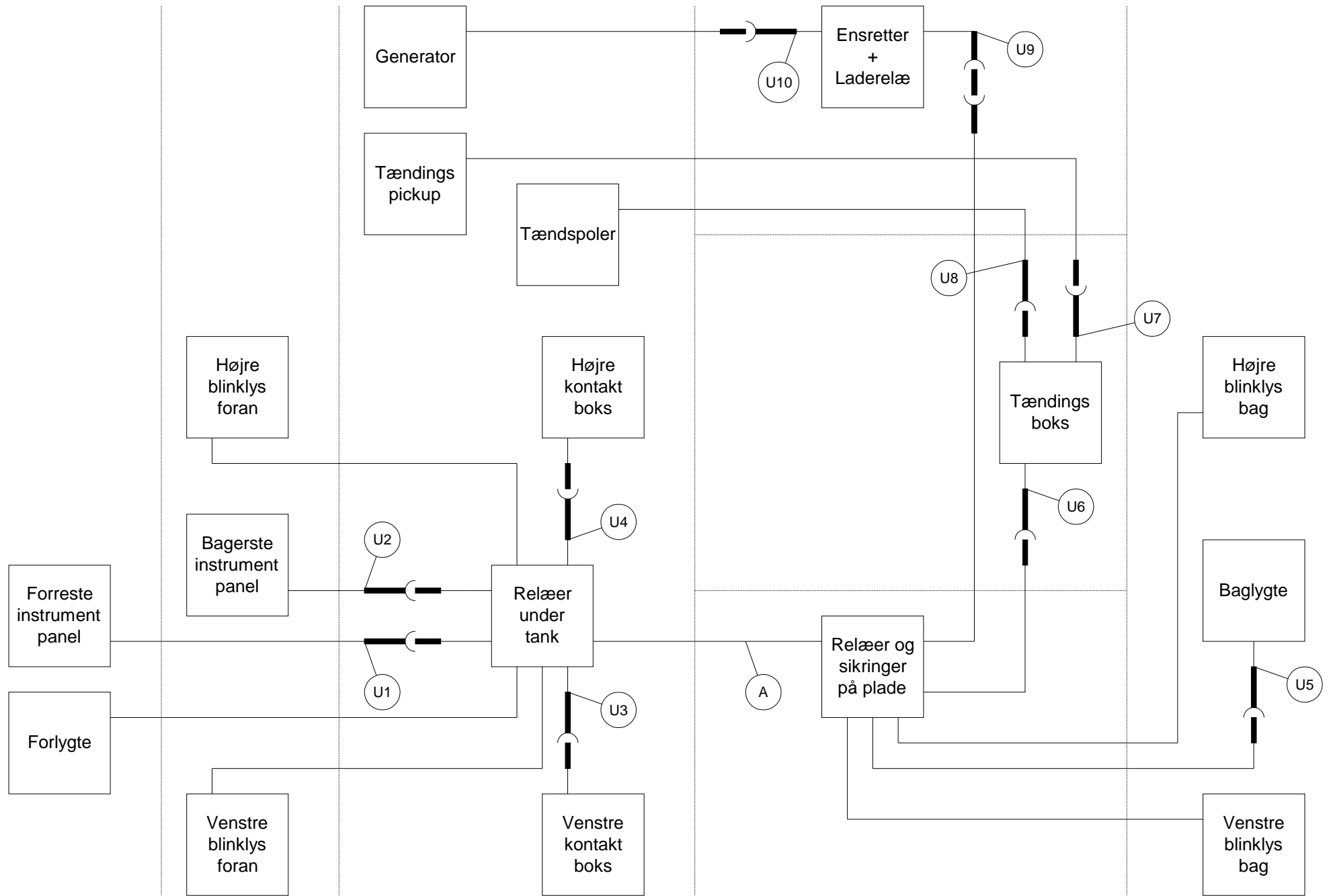

Moto Guzzi Le Mans II
Jens Lyck / 2000

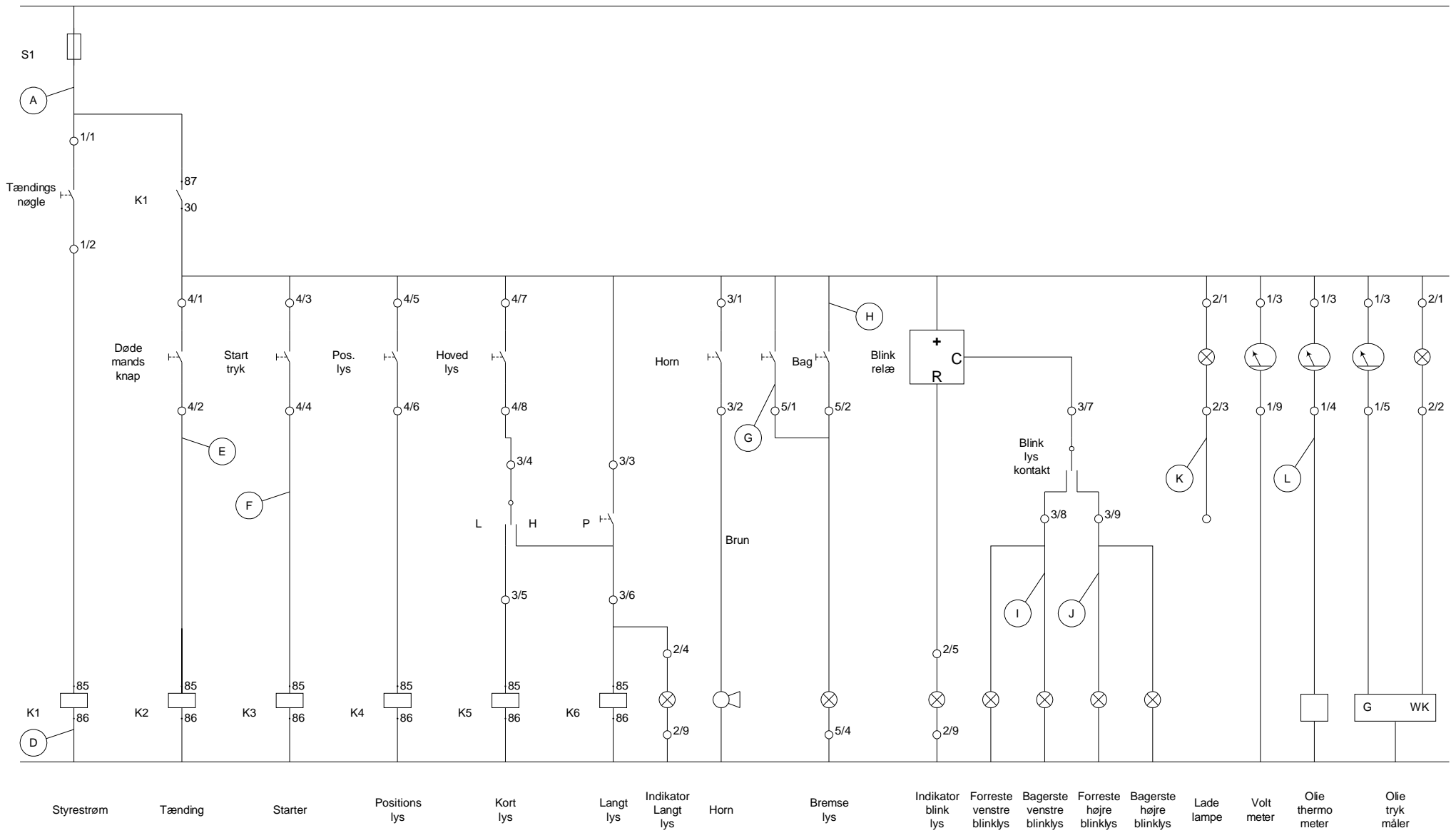

Moto Guzzi Le Mans II
Jens Lyck / 2000

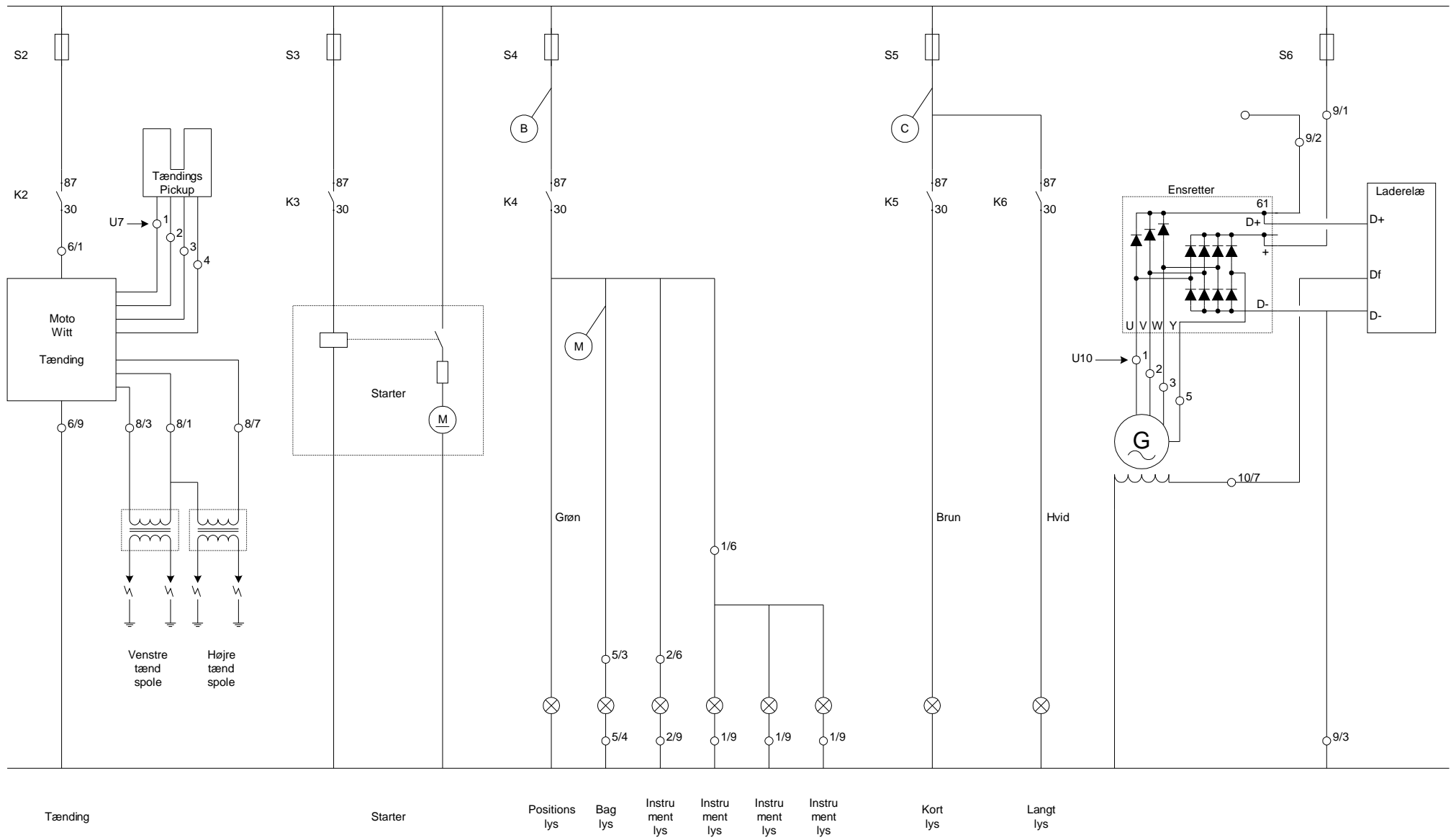

Moto Guzzi Le Mans II
Jens Lyck / 2000

Stik nr. 1
Forreste instrumentpænel

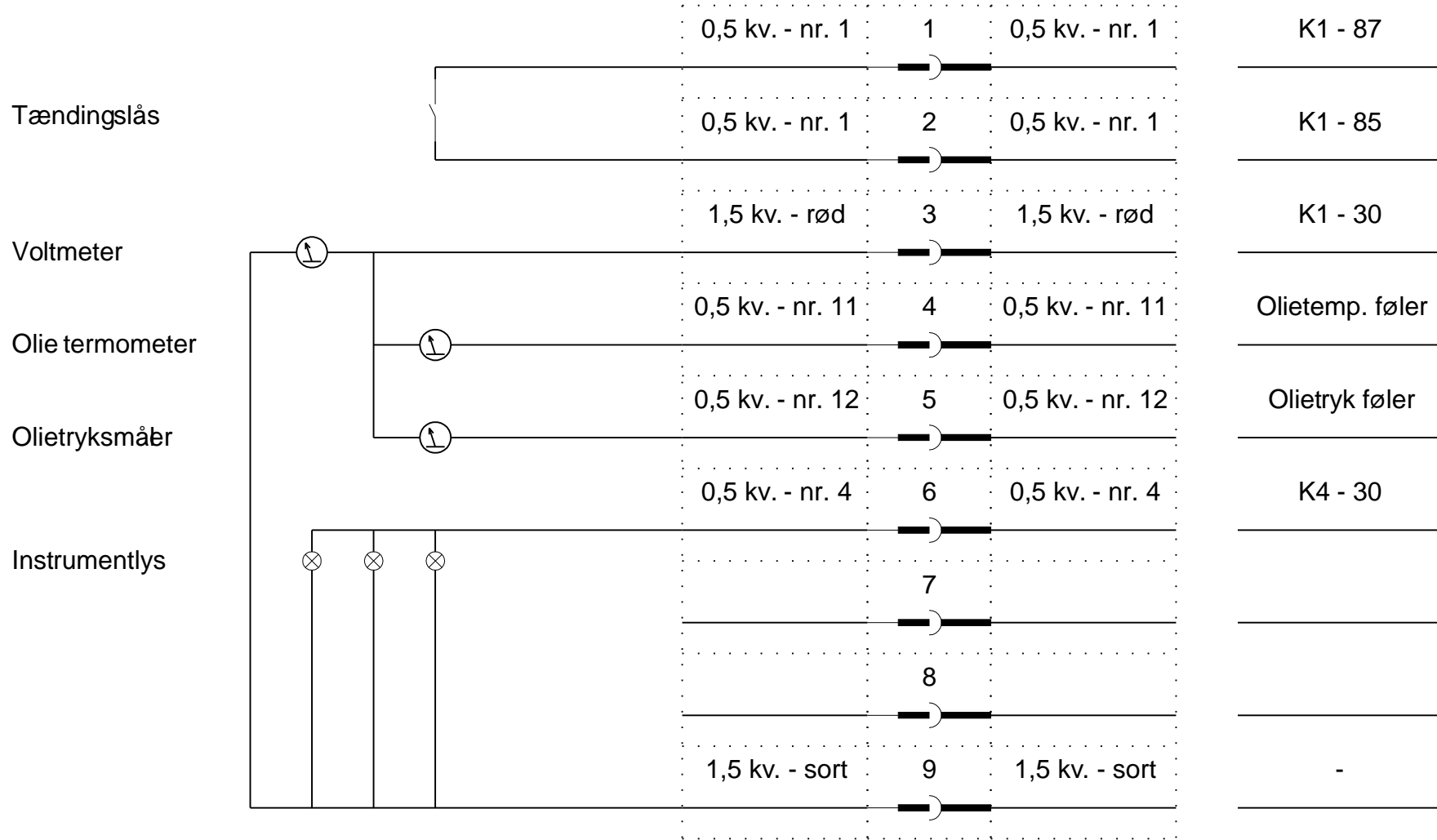
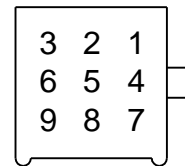
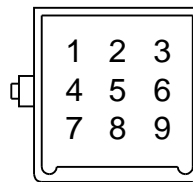

Moto Guzzi Le Mans II
Jens Lyck / 2000

Stik nr. 2
Bagerste instrumentpanel

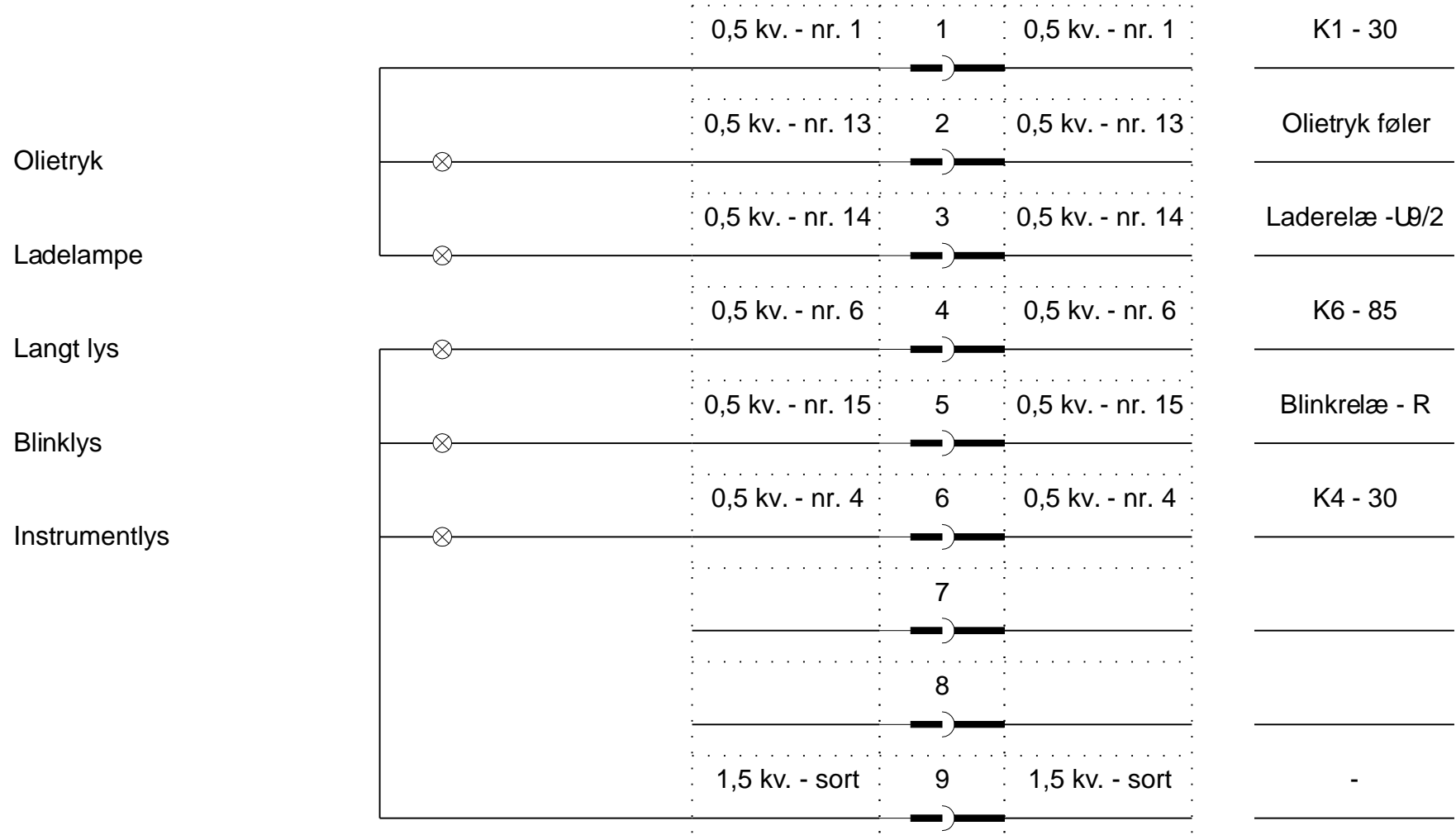
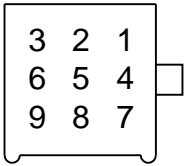
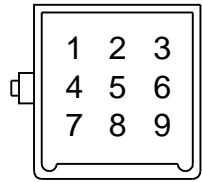

Moto Guzzi Le Mans II
Jens Lyck / 2000

Stik nr. 3
Venstre kontaktkab

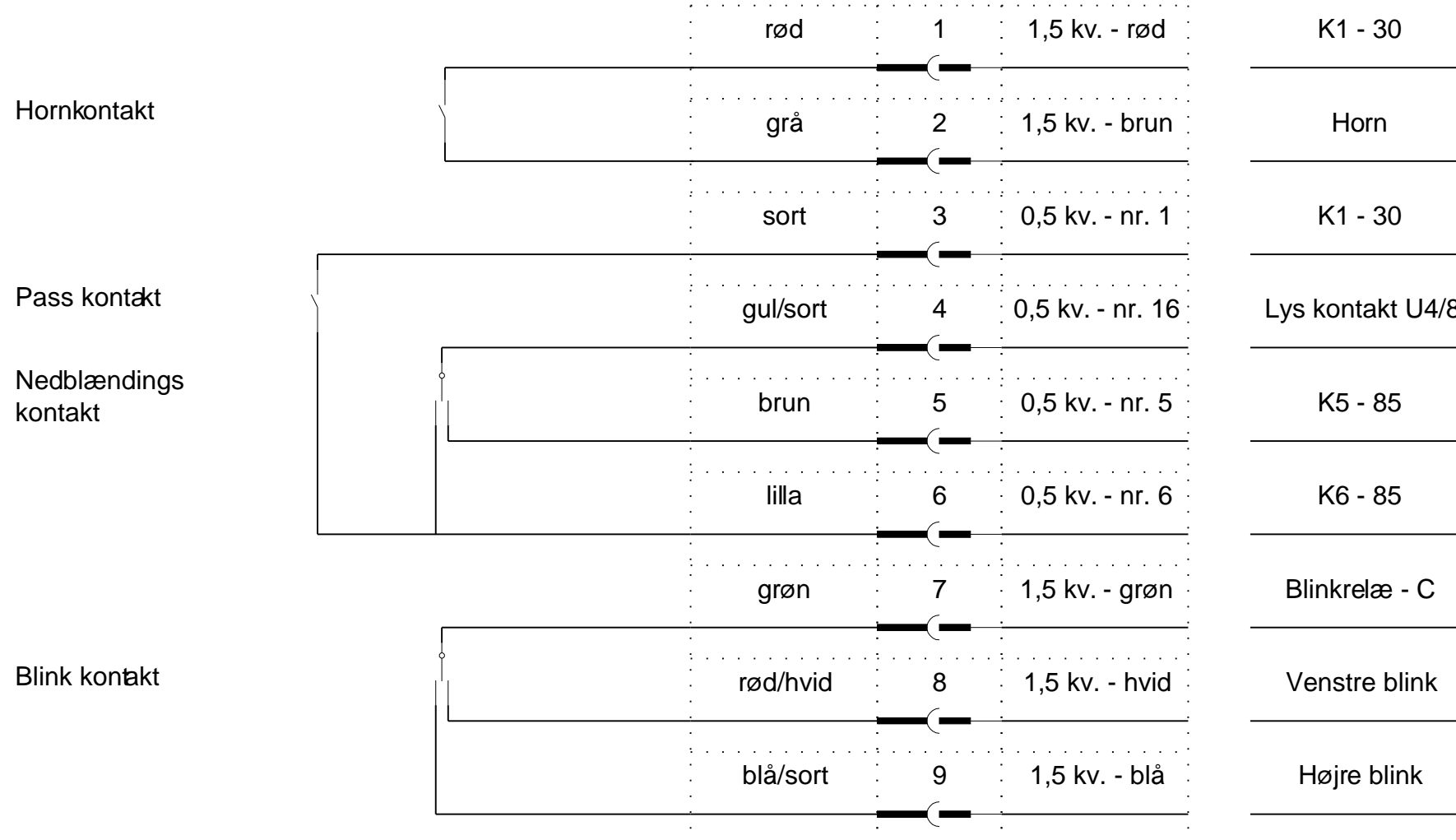
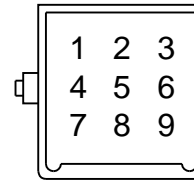
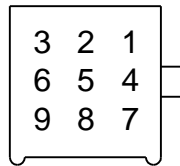

Moto Guzzi Le Mans II
Jens Lyck / 2000

Stik nr. 4
Højre kontaktboks

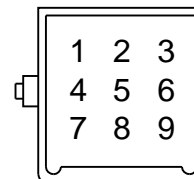
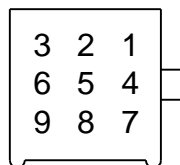

| | blå/hvid | 1 | 0,5 kv. - nr. 1 | K1 - 30 |
|----------------------|------------|---|------------------|----------------|
| Dødemands knap | hvid | 2 | 0,5 kv. - nr. 17 | Startspærre |
| | rød/hvid | 3 | 0,5 kv. - nr. 1 | K1 - 30 |
| Start tryk | sort/hvid | 4 | 0,5 kv. - nr. 3 | K3 - 85 |
| | rød | 5 | 0,5 kv. - nr. 1 | K1 - 30 |
| Positionslys kontakt | gul | 6 | 0,5 kv. - nr. 4 | K4 - 85 |
| | rød/sort | 7 | 0,5 kv. - nr. 1 | K1 - 30 |
| Hovedlys kontakt | rød/orange | 8 | 0,5 kv. - nr. 16 | Nedblænd. U3/4 |
| | | 9 | | |

Moto Guzzi Le Mans II
Jens Lyck / 2000

Stik nr. 5
Baglygte

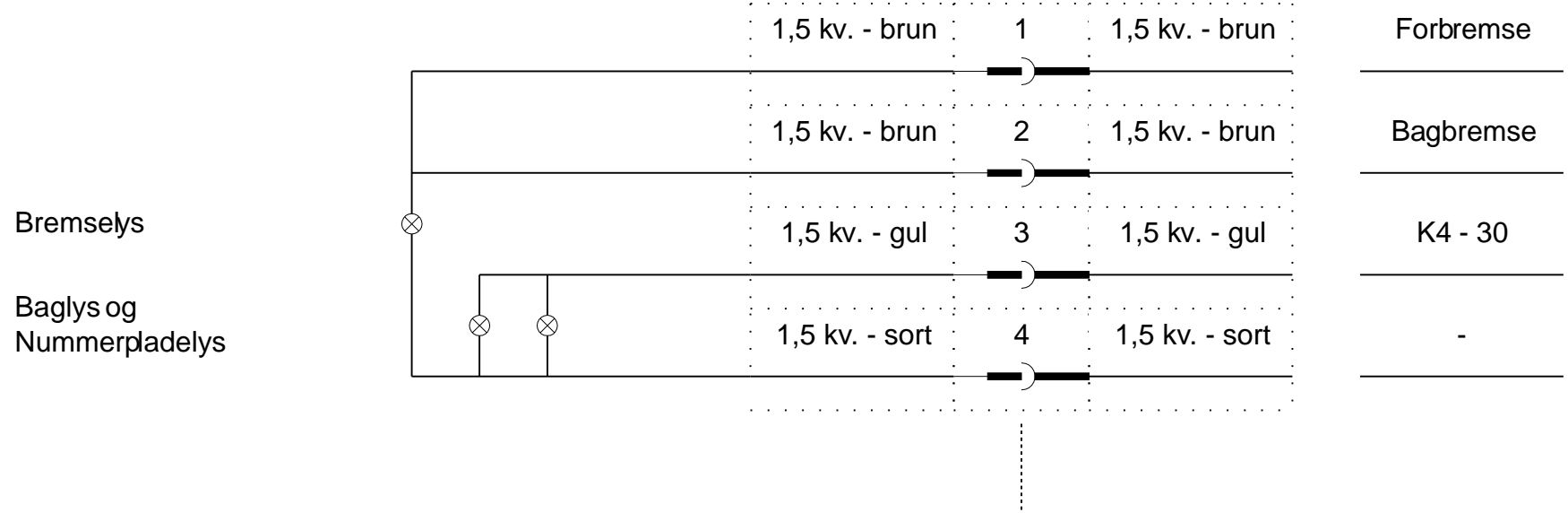
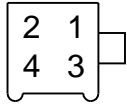
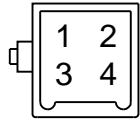

Bremselys

Baglys og
Nummerpladelys

Moto Guzzi Le Mans II
Jens Lyck / 2000

Stik nr. 6
Forsyning til tændingsboks

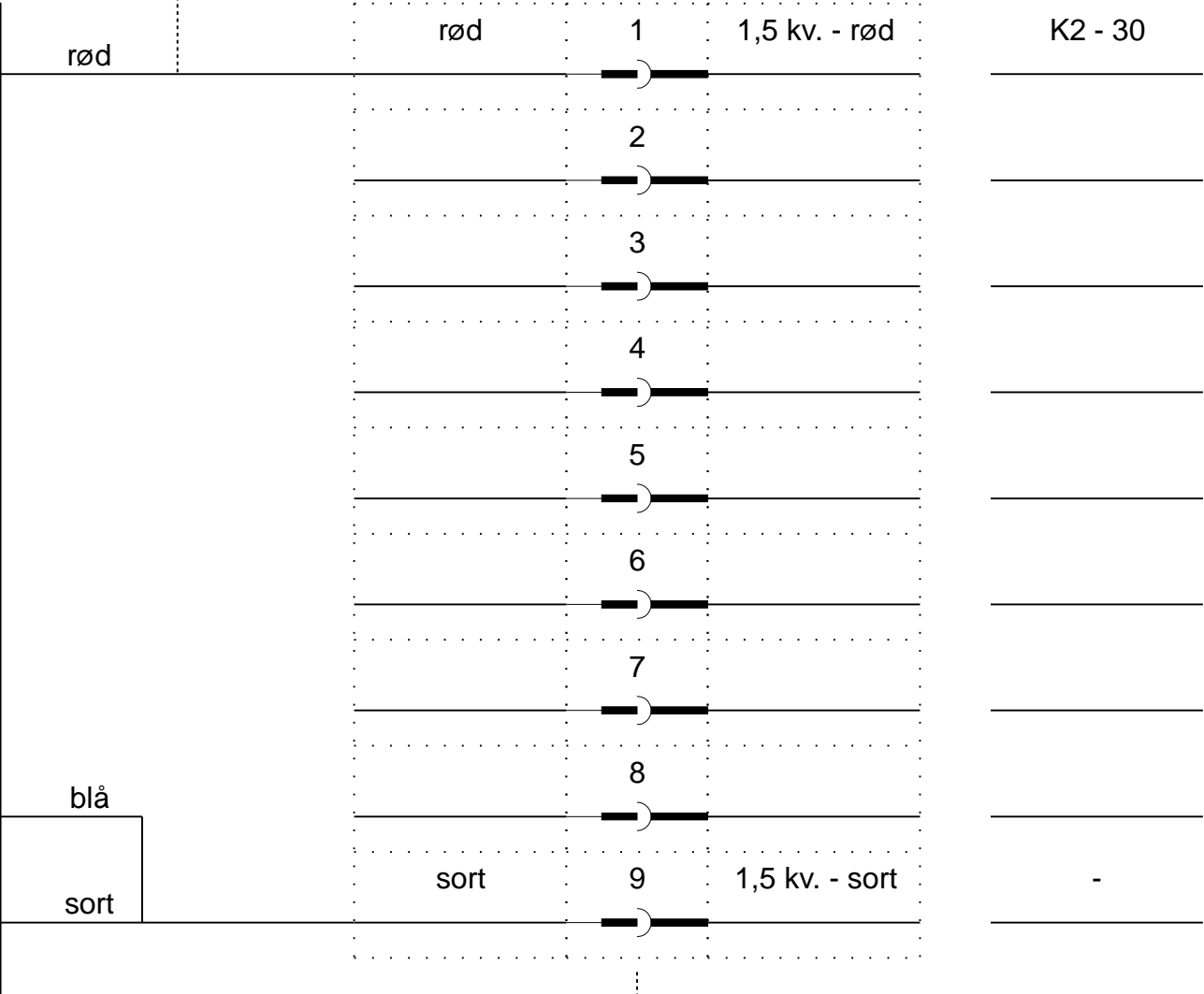
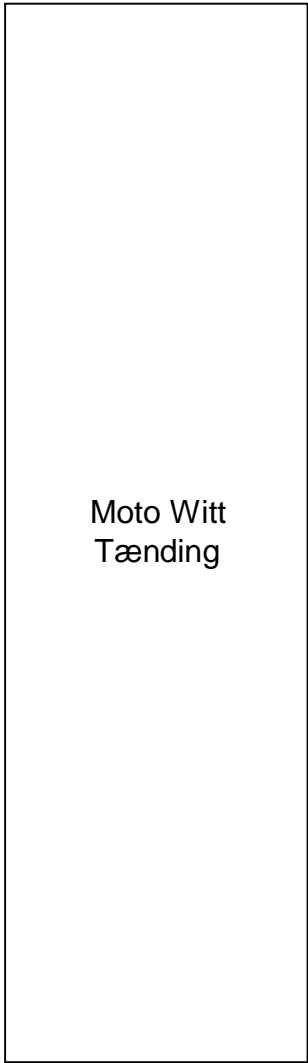
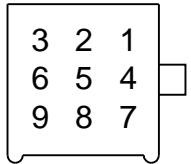
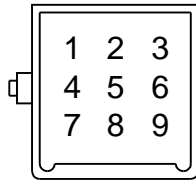

Moto Guzzi Le Mans II
Jens Lyck / 2000

Stik nr. 7
Tændingspickup

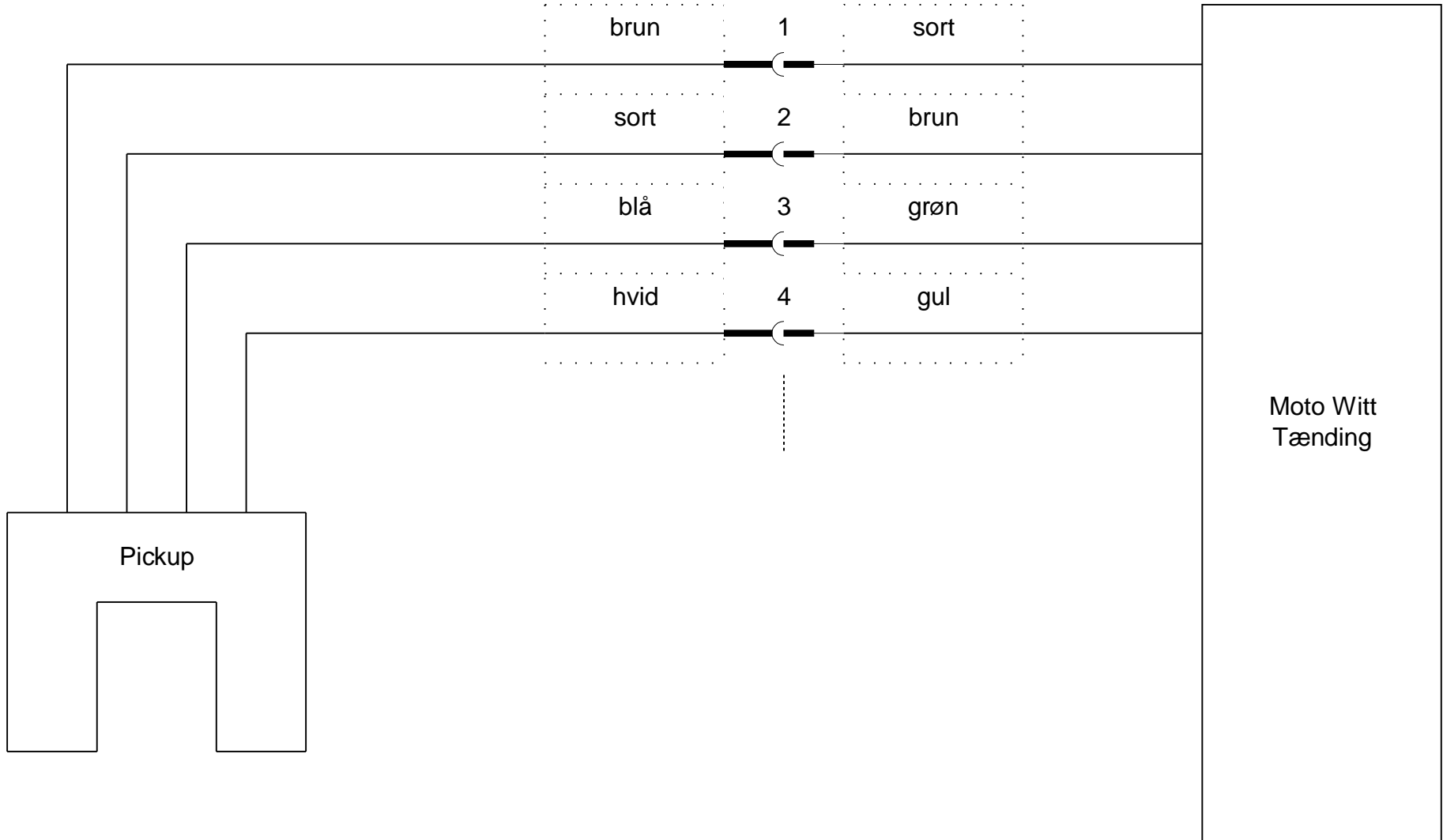
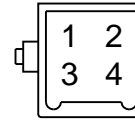
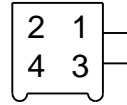

Moto Guzzi Le Mans II
Jens Lyck / 2000

Stik nr. 8
Tændspoler

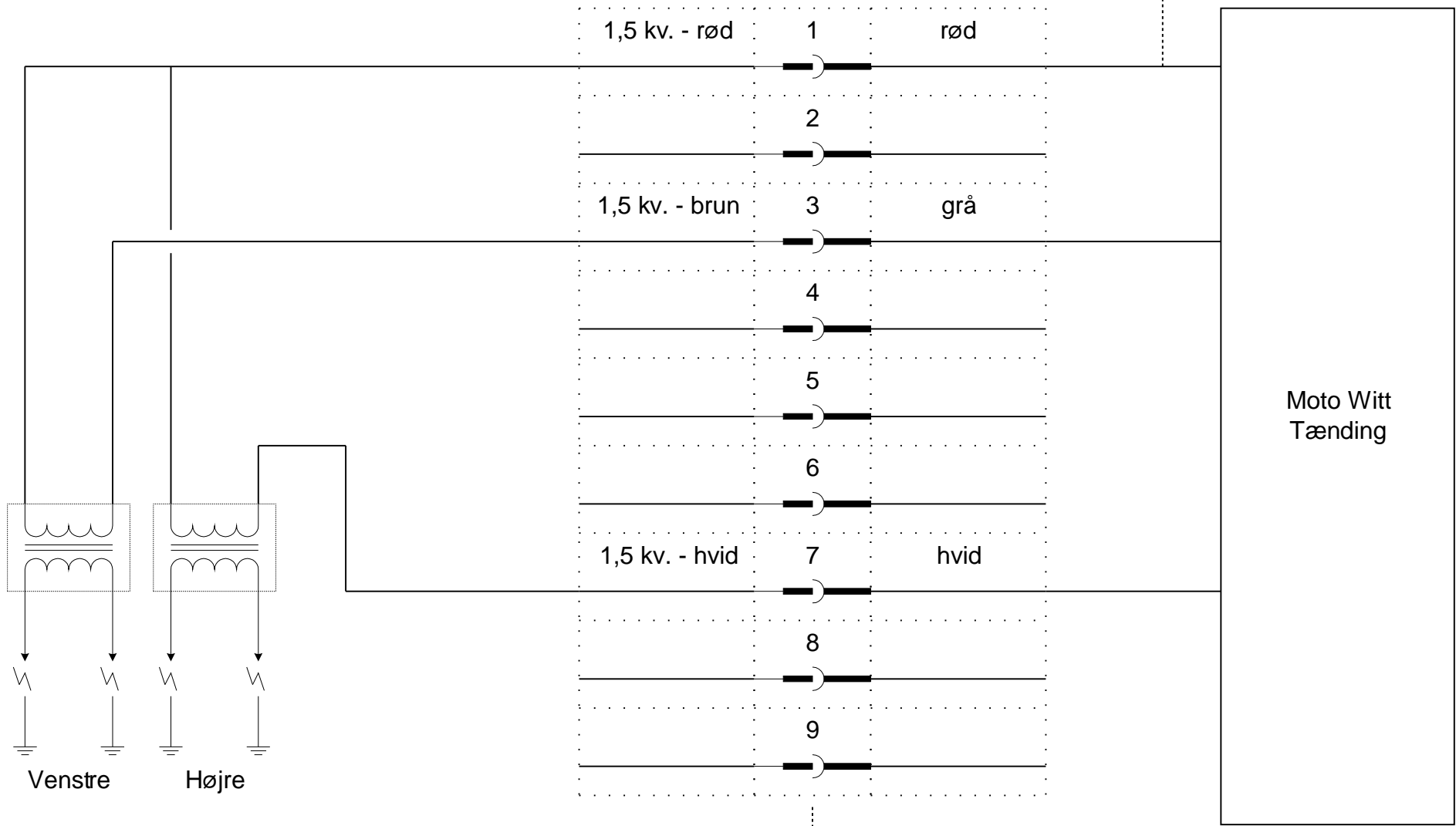
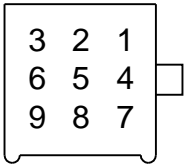
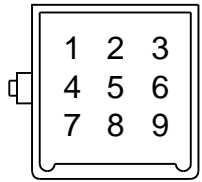

Moto Guzzi Le Mans II
Jens Lyck / 2000

Stik nr. 9
Ladestrøm

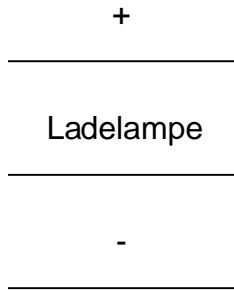
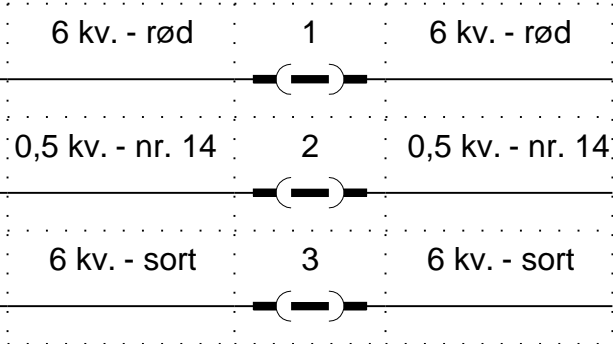
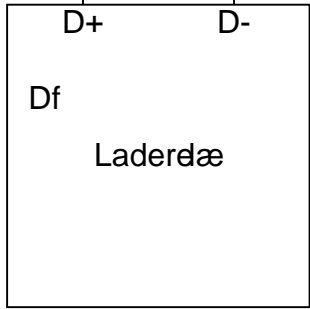
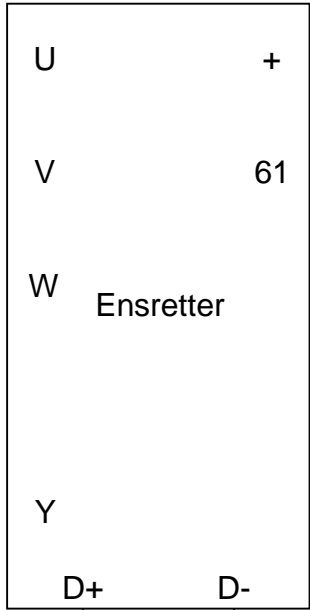

Moto Guzzi Le Mans II
Jens Lyck / 2000

Stik nr.10
Generator

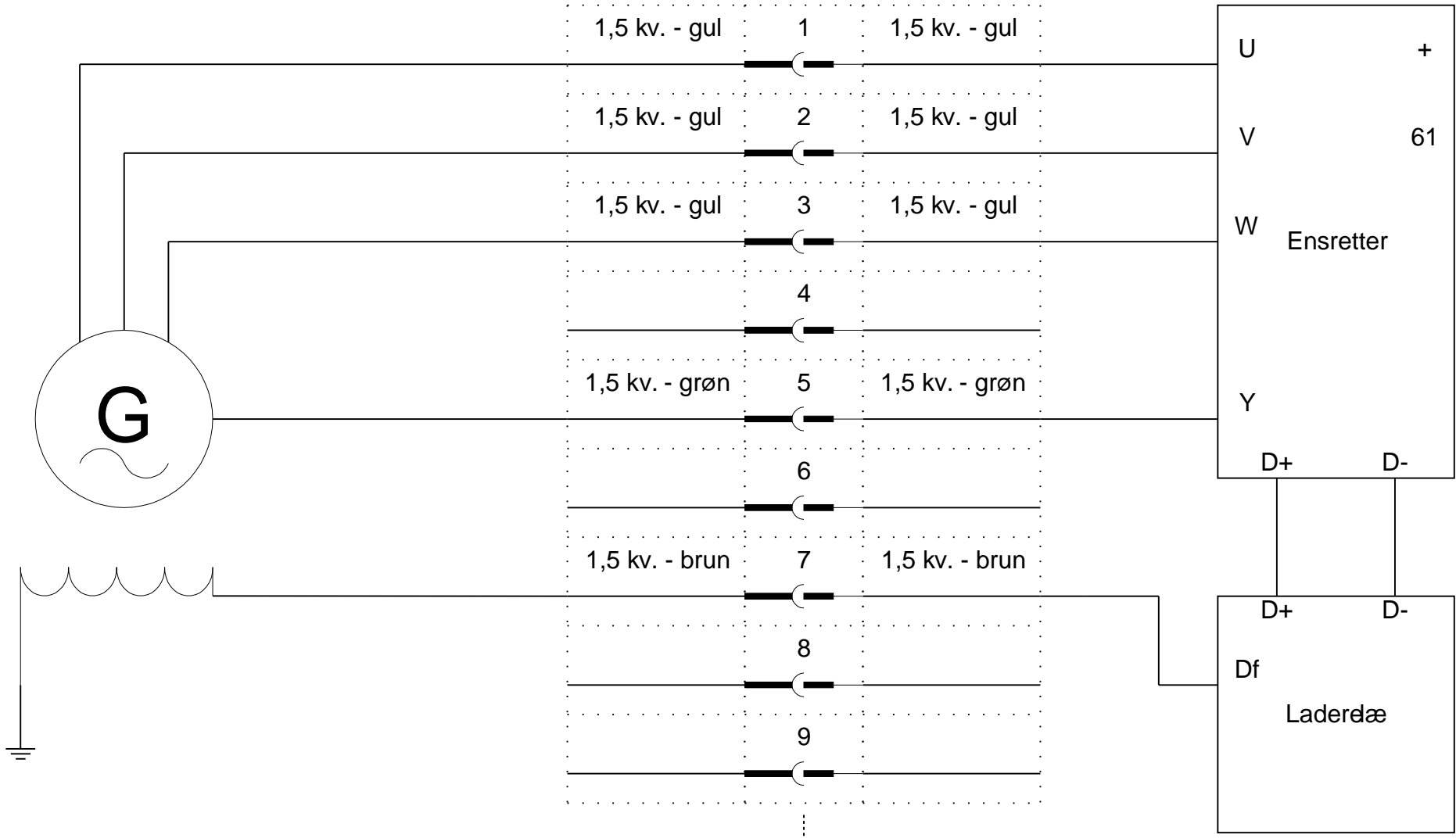
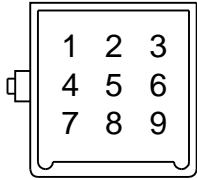
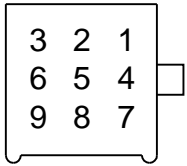

Moto Guzzi Le Mans II
Jens Lyck / 2000

Hovedkabel

For

| |
|---------------------|
| K1 - 87 |
| K4 - 87 |
| K5 - 87 + K6 - 87 |
| - |
| Dødemandsknap U4/2 |
| Starttryk U4/4 |
| Forbremse |
| K1 - 30 |
| Blinkkontakt U3/8 |
| Blinkkontakt U3/9 |
| Ladelampe U2/3 |
| Olietermometer U1/4 |
| K4 - 30 |

| | |
|---|------------------|
| A | 2,5 KV. - rød |
| B | 1,5 KV. - rød |
| C | 1,5 KV. - rød |
| D | 6,0 KV. - sort |
| E | 0,5 KV. - nr. 17 |
| F | 0,5 KV. - nr. 3 |
| G | 1,5 KV. - brun |
| H | 1,5 KV. - rød |
| I | 1,5 KV. - hvid |
| J | 1,5 KV. - blå |
| K | 0,5 KV. - nr. 14 |
| L | 0,5 KV. - nr. 11 |
| M | 1,5 KV. - gul |

Bag

| |
|-------------------|
| S1 |
| S4 |
| S5 |
| - |
| Startspærre |
| K3 - 85 |
| Bremselys U5/1 |
| Bagbremse |
| Venstre blink bag |
| Højre blink bag |
| Laderelæ U9/2 |
| Olietemp. føler |
| Baglys U5/3 |